



806001 - 806002

SINGLE ZEUS POLE

Square pole mounted floodlight for outdoor installation on a pole diam. 60 mm or 76 mm.

Phospho-chromatised and polyester powder coated die-cast copper-free aluminium body, tempered safety glass, moulded silicone gasket and stainless steel screws. Flange for pole diam. 60 mm or 76 mm included. Built-in LED driver 220-240V 50-60Hz, with 36 or 48 CREE XP-G2 LED. IP66 rating.

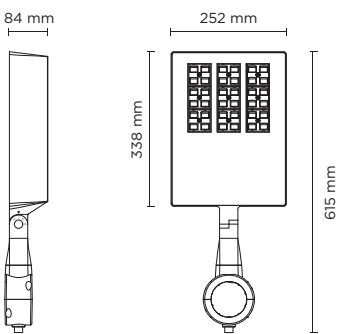

Technical features



Technical data





| | |
|-------------|--|
| IP Rating | IP66 |
| IK Rating | IK09 |
| Material | High corrosion resistance die-cast copper-free aluminum body |
| Coating | Polyester powder coating with phosphochromating pre-finish |
| Screws | Stainless steel |
| Transformer | Electrical power supply 220/240V 50/60Hz built-in |
| Gasket | Silicone rubber |
| Glass | Tempered |
| Cable gland | M16 rubber grommet |
| Power cable | Not included |
| Weight | Kg 5,50 |

CYCLE ROUTE / PEDESTRIAN







STREET

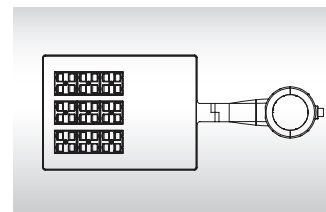

| | | | | |
|-----------------------------|--|--|-------------------------------|--|
| 806001 | | SINGLE ZEUS POLE 36 56 WATT 220-240V 50-60HZ | | |
| light source* | light beam options | lumen output (lm) | lumin. efficacy (lm/w) | |
| 3000°K warm-white | | | | |
| high power led |  cycle route pedestrian | 4.888 | 87.28 | |
| high power led |  street | 4.888 | 87.28 | |
| 4000°K neutral-white | | | | |
| high power led |  cycle route pedestrian | 5.040 | 90.00 | |
| high power led |  street | 5.040 | 90.00 | |

* Other light colors available on request: Neutral-white



| | | | | |
|-----------------------------|--|--|-------------------------------|--|
| 806002 | | SINGLE ZEUS POLE 48 75 WATT 220-240V 50-60HZ | | |
| light source* | light beam options | lumen output (lm) | lumin. efficacy (lm/w) | |
| 3000°K warm-white | | | | |
| high power led |  cycle route pedestrian | 6.474 | 86.33 | |
| high power led |  street | 6.474 | 86.33 | |
| 4000°K neutral-white | | | | |
| high power led |  cycle route pedestrian | 6.675 | 89.00 | |
| high power led |  street | 6.675 | 89.00 | |

* Other light colors available on request: Neutral-white

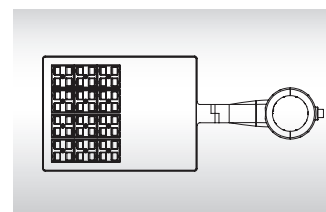

Colors options

-  Textured Grey RAL 9006
-  Anthracite Grey RAL 7016
-  Matt Black (on request)

POLES & ACCESSORIES

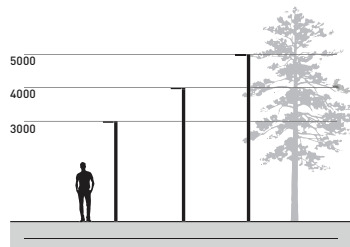

BURIED POLES

| code | article | h. mm. | description |
|--------|--|--------|--|
| 809901 | cylindrical pole 3,5 meters to be buried | 3.500 | Cylindrical pole made in steel S235JR (UNI EN 10219) hot galvanized (UNI EN 1461), diameter 76 mm, thickness 4 mm. |
| 809902 | cylindrical pole 4,5 meters to be buried | 4.500 | Phospho-chromatised and polyester powder coated. Total height including 500 mm to be buried into the ground. Includes IP54 cover plate 132x38 mm and terminal block in double insulation. |
| 809903 | cylindrical pole 5,5 meters to be buried | 5.500 | |
| 809909 | Top cap for pole diam. 76 mm. | | |

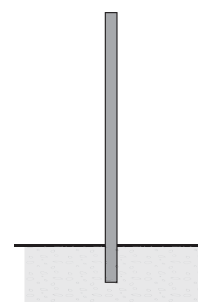

POLES WITH BASE-PLATE

| code | article | h. mm. | description |
|--------|---|--------|---|
| 809904 | cylindrical pole 3 meters with base-plate | 3.000 | Cylindrical pole made in steel S235JR (UNI EN 10219) hot galvanized (UNI EN 1461), diameter 76 mm, thickness 4 mm. |
| 809905 | cylindrical pole 4 meters with base-plate | 4.000 | Phospho-chromatised and polyester powder coated. With base plate dim. 250x250 mm, thickness 10 mm |
| 809906 | cylindrical pole 5 meters with base-plate | 5.000 | Includes IP54 cover plate 132x38 mm and terminal block in double insulation. |
| 809907 | anchorage unit for base-plate | | Base plate dim. 250x250 mm, thickness 3 mm, made in galvanized steel complete of nr. 4 anchorage threaded bolts |
| 809909 | Top cap for pole diam. 76 mm. | | |

